



Utility Systems—Electrical

The electrical supply to your home begins outside, where you will see either an overhead feed and piping down the side of your home or (if you have underground service) a metal box near the ground. **See Figure 4-1.**

The overhead service wire should be clear of trees and other wires. It should be at least 10 feet above any surface you can walk on.

With underground service, you will see a meter mounted on the metal box. This box hides the entrance of the service wire into your home.

The main electrical panel will be located in the basement or utility room. From this panel, electricity is divided into circuits through individual breakers or fuses and is fed through the wiring system, outlets and cords to various electrical devices.

Most modern homes have 220-volt systems with a minimum of 100 amps of power. Older houses may have fuses and can have 60-amp systems. Very old houses can have 110-volt, 30-amp systems, but these are rare.

Main Panel

Take a tour of your main electrical panel. Do this with a professional or an experienced friend if you are confused or if you have particular questions or concerns.

During this tour, identify the main disconnects so you can turn off power in an emergency. Also, determine how to reset a breaker and/or replace a fuse.

To begin, locate the main panel and open the door. Do not remove the metal cover beneath, since that would expose bare wires.

You will find fuses or breakers but not bare wires or exposed connectors. Breakers look like switches that can be moved from “on” to “off.” Fuses will be either a round screw-in type or the larger cartridge type mounted in a fuse block that can be pulled from the main panel.

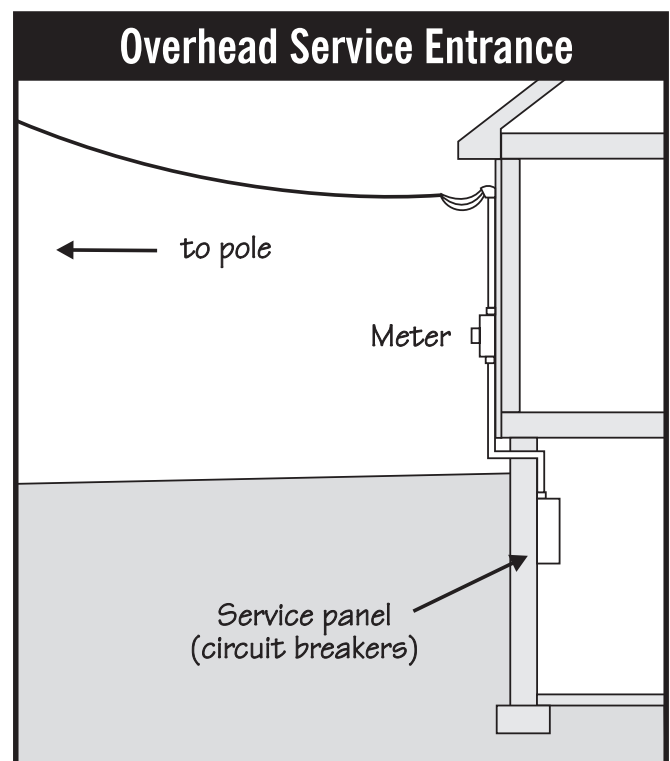
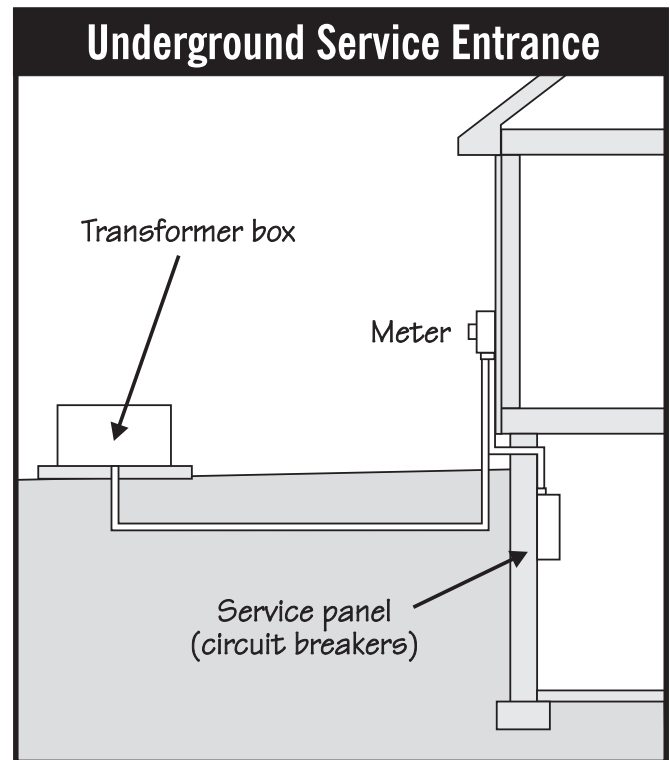

Figure 4-1.



Must Know / Must Do—Electrical

Properly installed electrical systems are very safe and efficient. To prevent safety problems, though, you should understand the basics.

- Know where the main electrical disconnect is located and how to use it.
- To prevent shocks, any outlets near water (such as next to a sink) and all exterior outlets should have GFCI protection installed. (These outlets are explained below.)
- Know which outlets are GFCI protected. Test GFCI outlets and breakers monthly.
- Avoid using extension cords.
- Never attempt an electrical repair unless you know exactly what you are doing.
- Never perform wiring or re-wiring work. Use a professional.
- Identify which breakers/fuses control which outlets.
- If you replace a fuse, always use the same size—20 amp for 20 amp, 15 amp for 15 amp. Have a few spare fuses on hand.
- Know how to reset a breaker. The usual procedure is to turn it off, then on. Some systems use red indicators or an “off” indicator to show that a breaker has been tripped.
- Never cut or modify electrical plugs or outlets.

Other configuration are possible. There may be a combination of fuse panels and breaker panels. There may be “sub-panels” located next to the main panel.

Breaker Panel—Main Switch

On most panels, you will find one breaker marked “main.” This breaker will be near the top of the box and will be 100, 150 or 200 amp. If you

switch this breaker off, all power in your home will be disconnected, and you will be in the dark. I don't suggest turning off the power. **See Figure 4-2.**

An older breaker panel may have several breakers marked as main disconnects. Some may be marked “lighting” or “air conditioning.” There may also be a fused main with breakers for distribution circuits.

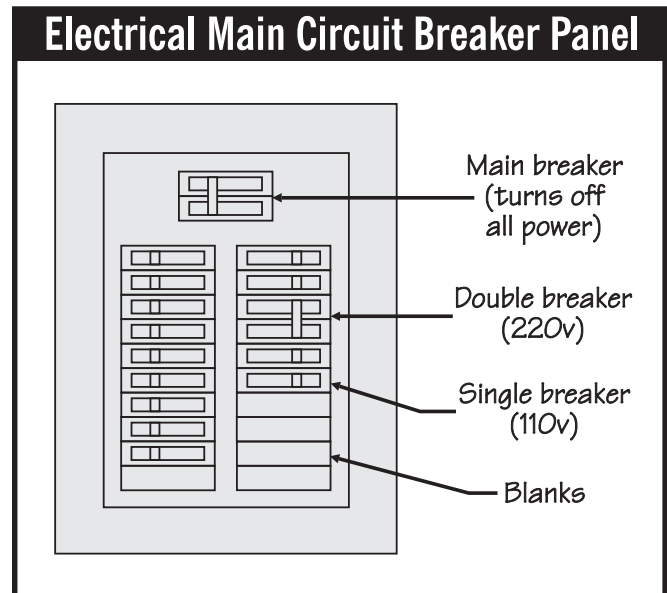

Figure 4-2.

Breaker Panel – Reset a Breaker

Modern circuit breaker panels are convenient because you can “reset” a breaker if it trips and you don't need to search for a replacement fuse. You do need to use common sense and caution when resetting a breaker. If a breaker trips, there may be an overload on the circuit. Before you switch a breaker back on, check for devices that may be causing the overload – hair dryers, electrical resistance heaters, power tools or other devices that use a lot of power. Remove the device before you reset the breaker. If the breaker trips a second time – consult a professional.

There are several types of breakers and methods to reset breakers **See Figure 4-3.** Most breakers flip to an “off” position when an overload occurs. For these breakers, you flip the switch back to the “on” position. Some breakers also have a little window that shows a red “flag” when the breaker is tripped.

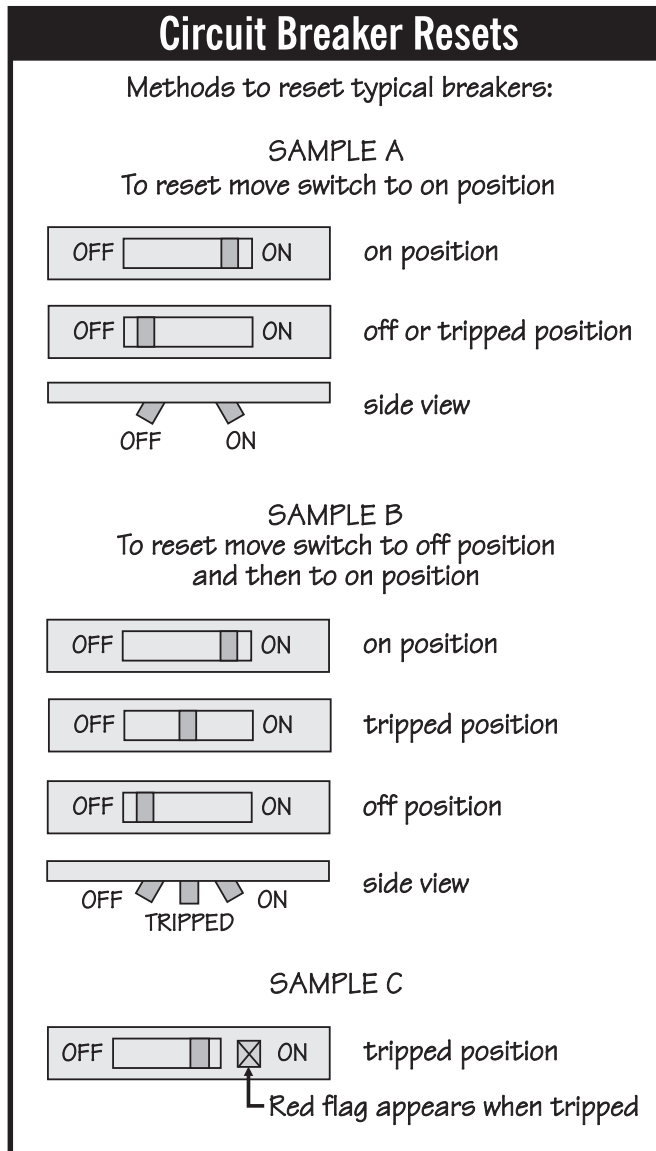

Figure 4-3.

Other breakers flip to a center position when tripped. The handle will be halfway between “on” and “off”. You will need to look carefully to find this type of tripped breaker. This type of breaker often requires you to move the breaker handle to the “off” position and then back to the “on” position to reset the breaker.

Fuse Panel—Main Switch

You will see a main fuse block, about 4”x 3”, with a small handle. Turning off (“pulling”) this main turns off all power to your home. **See Figure 4-4.**

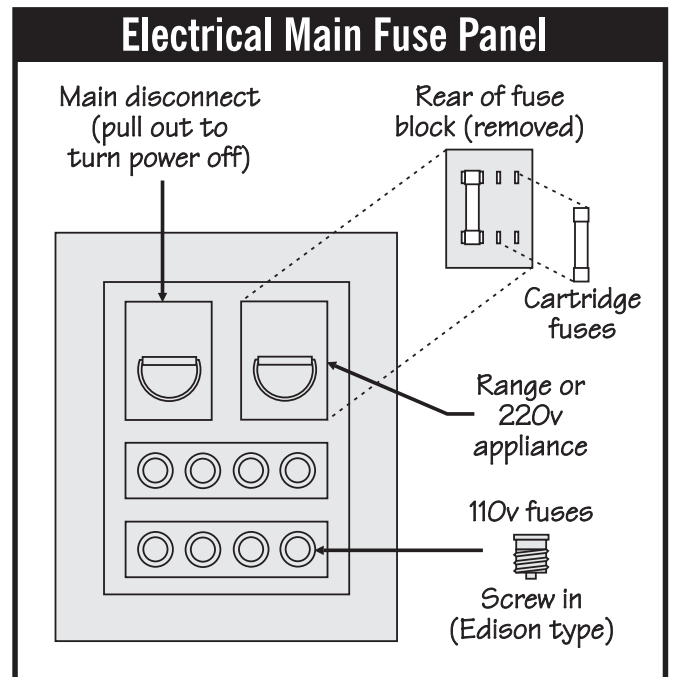

Figure 4-4.

Some older systems have multiple main disconnects—instead of pulling one main, you must pull multiple fuse blocks to turn off all power. Main disconnects should be clearly identified at the fuse blocks or on the cover of the panel. They may be marked “lighting main,” “range,” “dryer,” “air conditioner,” and so on. Usually, each 220-volt appliance has its own main.

If this sounds confusing, review the sketches I’ve provided. If you still don’t understand your system, or if it’s not well-marked, go over the panel with a professional and rewrite the markings.

Fuses and Replacement

Typical screw-in type fuses are called Edison Base fuses. They fit into a threaded socket just like a light bulb. **See Figure 4-5.** If a fuse “blows”, it will appear dark or burned in the cover window. To replace a fuse you unscrew the old fuse and screw in a new fuse of a matching amperage rating. The “blown” fuse is discarded. You should always match the amperage rating and never put a larger fuse in the socket. For example, a 15-amp fuse must be replaced with a 15-amp fuse NOT a 20-amp fuse.

You can improve the safety of your fuse system by adding S-Type fuse bases. **See Figure 4-5.** This base is a special socket that is threaded into the standard size, Edison socket. Once in place, they will only accept the correct size fuse. Each S-Type fuse has a unique threaded base. Safety is provided because a 20-amp fuse will not fit in a 15-amp S-Type fuse socket.

Wiring, Flow of Electricity

Distribution wiring is what routes electrical power to lights, outlets and appliances. Most of this wiring is buried in walls and attics, but some will be visible near the main panel and in basements and crawl spaces. Since the 1970s, plastic shielded wiring (Romex is a common brand) has been used in residential construction. Older homes may have cloth-shielded wiring, BX or flexible metal-shielded wiring, or even conduit (metal pipe). There are many variations and exceptions. **See Figure 4-6.**

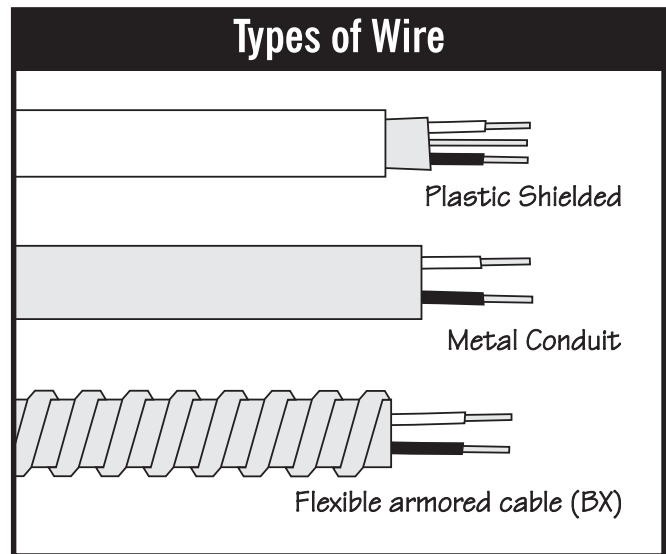

Figure 4-6.

Homes built around 1910 may have “knob and tube” wiring that consists of two strands of wire run parallel. This wiring is strung on knobs, around corners, and through tubes in framing. It should only be modified by a professional. If your home has this type of wiring, plan for an upgrade.

Electricity flows like water, so it requires at least two wires: it pushes through the live wire and returns through the neutral wire. This is why all electrical devices have plugs with at least two prongs. Modern systems add a third (ground) wire for safety.

Devices like electric ranges run on 220 volts and require two power wires (110v plus 110v) plus the neutral wire. Some 220-volt appliances have four wires: two power, one neutral, and one ground.

Sound complicated? It is. Don't modify or tamper with the system. Consult a professional when repairs are needed. Experience and knowledge are necessary when working with electricity. Electricians spend at least six years in school and training just to learn the basics of their trade.

Outlets, Cords, 110 vs. 220

220 volt—what?? Is that 110, 220, 240 or 90210? Terminology used with electrical systems is confusing, but you really don't need to sweat it. In

Typical Screw in Fuses

Edison Base Fuse



New



Blown (open)

S-Type Fuse



Fuse



Base/socket

For the S-type fuse, a special base or socket is screwed into the fuse opening and remains in place. This socket will only accept fuses of the correct amperage rating because of the special threads/socket.

Figure 4-5.

fact, electric utility companies don't provide an exact voltage. Just remember this:

Electricity is provided to your home with a nominal (approximate) voltage of 110 to 120 volts per wire. When you connect between the two live wire feeds, you double the voltage to about 220 or 240 volts. So you can call it 110 or 120 volts for smaller appliances and 220 or 240 volts for large appliances.

How can you tell the difference? 110 volt is provided to all convenience outlets, light switches, and lighting fixtures in your home. The standard electrical outlet is 110 volt. **See Figure 4-7.**

Large appliances like stoves and electric clothes dryers use 220/240-volt outlets. These are the big clunky outlets. Electric water heaters, central air conditioners, and heat pumps are directly connected to 220/240-volt power without a plug. Some large electric appliances may also be directly wired.

Just to confuse you, you may find a funny looking small outlet and plug that is the same size but a different shape than a standard 110-volt outlet. These are 20 amp, 220/240-volt outlets. These are not

common but they may be found for large window air conditioners, woodworking equipment, and shop air compressors. A standard plug will not fit into a 220/240-volt outlet.

Service Disconnects

Electrical equipment is often connected to the electrical system with a plug or service disconnect as a safety measure. All equipment must have a readily available means of disconnection from the electrical system in case the unit needs servicing. **See Figure 4-8.**

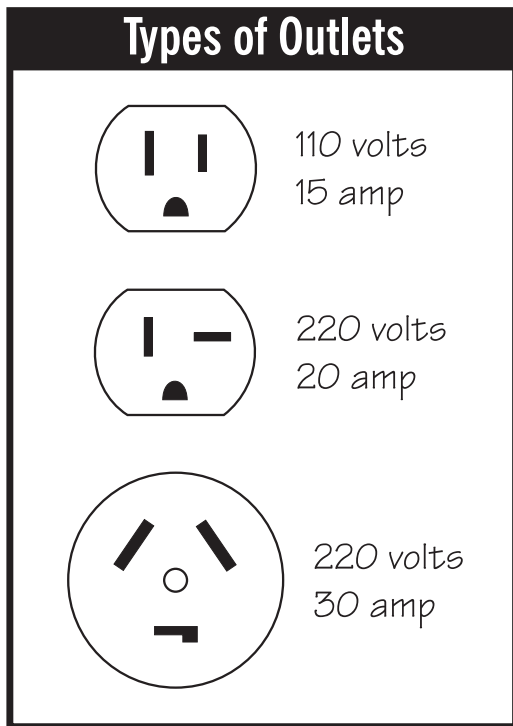

Figure 4-7.

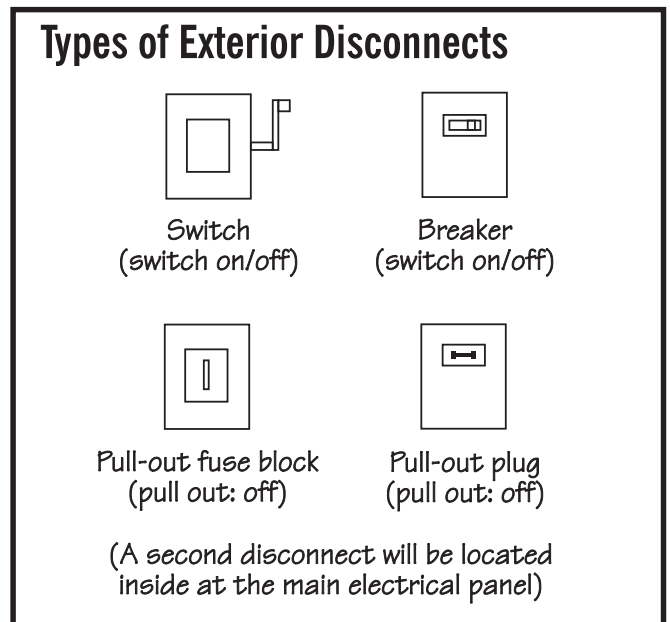
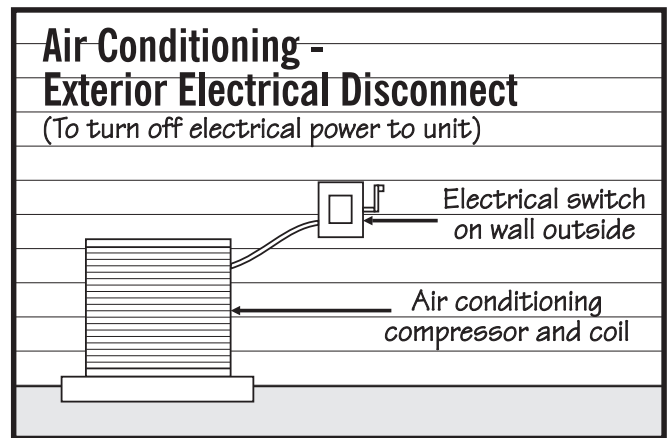

Figure 4-8

Common service disconnects:

- Furnace—"light switch" on the side of the unit
- Central air conditioner—switch or pull-out in a box next to the exterior unit
- Dishwasher—"light switch" above the kitchen counter.

Know where the service disconnects are located and how to use them.

Electrical Polarity

Polarity is an important concept. For safety's sake, you need to understand the basics.

Electricity circulates through wires just like water moves through a hose. In the case of a lamp, for instance, electricity pushes through the "hot" wire, lights the bulb, and returns through the neutral wire. Got it?

Plugs on modern lamps and other devices have one wide blade and one narrow blade so that they can be plugged into an outlet, **see Figure 4-9**, in the correct position only—unlike plugs on old lamps, which could be reversed. Electrical devices with three-prong plugs have a ground wire; these,

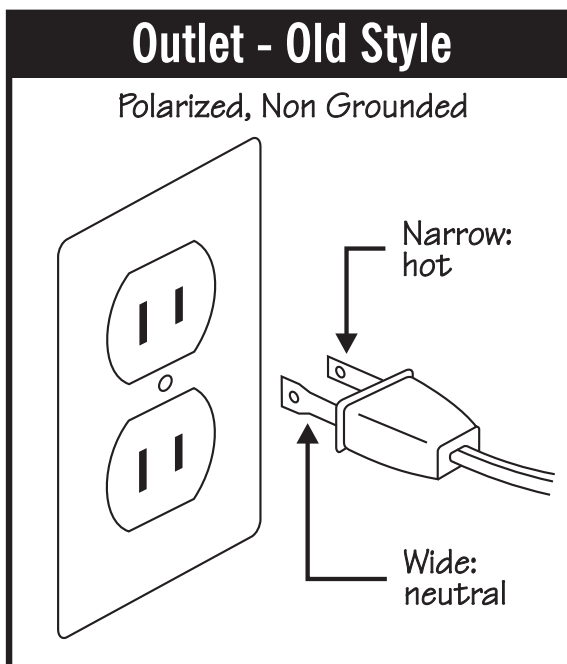

Figure 4-9.

too, can only be plugged into an outlet in one position. **See Figure 4-10.**

You may find a modern electrical tool with a plug that has two narrow blades that can be inserted in either direction. These are special "double insulated" tools with plastic housings that isolate the electrical components from contact with your skin.

What happens if you power a device with "reversed polarity"—that is, with the plug reversed? Stereo equipment may buzz; electrical and computer equipment may be damaged. Lights and lamps pose a serious hazard. When turning off the switch, you would be turning off the neutral (return) wire, not the live (hot) wire. This means that even when the lamp is off, the ring around the base of the bulb is still live, and if you touch the ring you can get a serious shock. **See Figure 4-11.**

What does all this mean to you? Never change a plug or outlet unless you understand polarity and know exactly what you are doing.

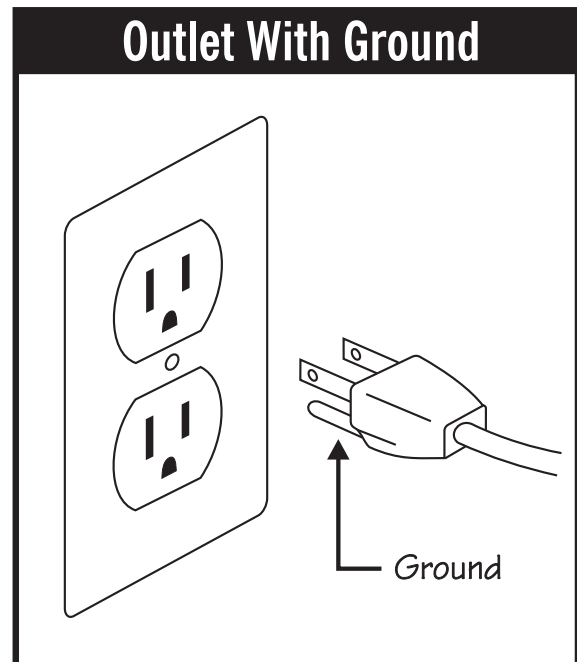

Figure 4-10.

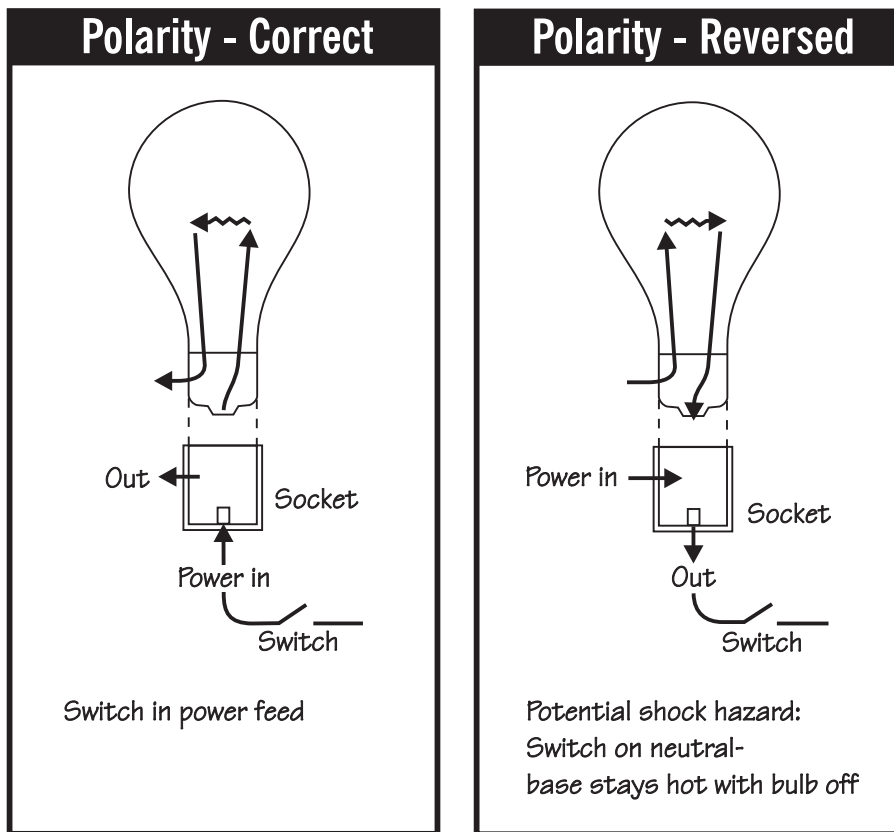

Figure 4-11.

Electrical Grounding

Electrical devices with metal housings—stoves, dryers, tools—often have a grounded plug. A grounded plug has a third, round connector. Grounded plugs provide an extra level of safety by grounding the metal housing of the device. Never remove the grounding device from a grounded plug. Never use adapters that convert a grounding plug to a standard two-prong plug. If your electrical device has a grounded plug, it should only be used with a grounded outlet. If there's no grounded outlet where you need it, have one installed.

Ground Fault Circuit Interrupters

A ground fault circuit interrupter (GFCI), **See Figure 4-12**, is a valuable safety device that should be installed in bathrooms, kitchens, sink locations, the garage, and exterior outlets. GFCIs have been required in new construction and

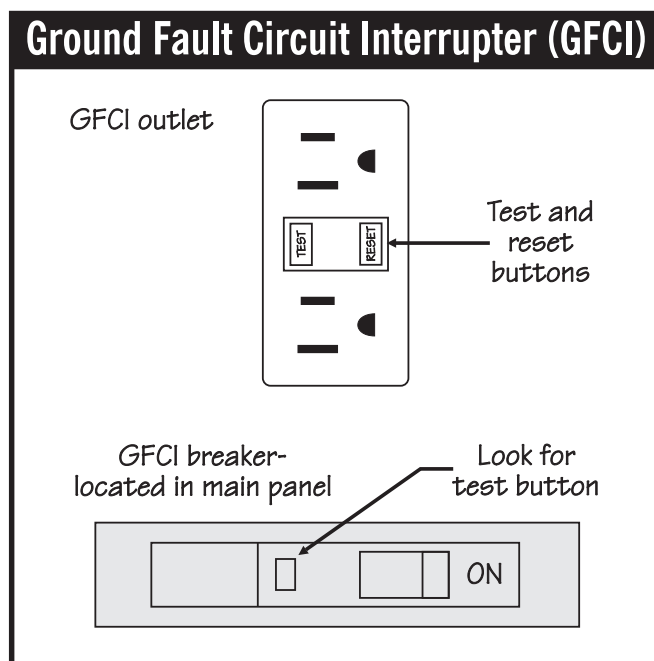

Figure 4-12.

remodeling since the mid-'70s. If you are remodeling, add GFCI outlets in the bathroom and any other damp or wet location. Have an electrician perform this work.

GFCI outlets or circuit breakers provide a high level of safety for very little cost. The GFCI outlet costs less than \$10 and can be installed in a few minutes in most locations.

A tiny imbalance in the power and neutral lines will trip the GFCI. The imbalance indicates potential current leakage that could deliver a shock.

Don't confuse a GFCI with the fuse or circuit breaker in the basement. The fuse or breaker protects the wire from overloads, overheating and burning. A fuse will allow 15 or 20 amps to flow through the circuit before it trips. This is more than enough power to electrocute you.

Once the GFCI is installed, test it monthly with the test/reset button on the face of the breaker or outlet. Testing is simple and essential. Push the test button, and the GFCI will trip. Reset the GFCI outlet by pressing the reset button on the face of the outlet. Reset a GFCI breaker (at the main panel) by moving the switch from the center "tripped position" to fully "off" and then to the "on" position. **See Figure 4-13.**

Unfortunately, most outlets are not tested. I provide home inspection services, and I find that 5% to 10% of existing GFCI outlets are not working properly.

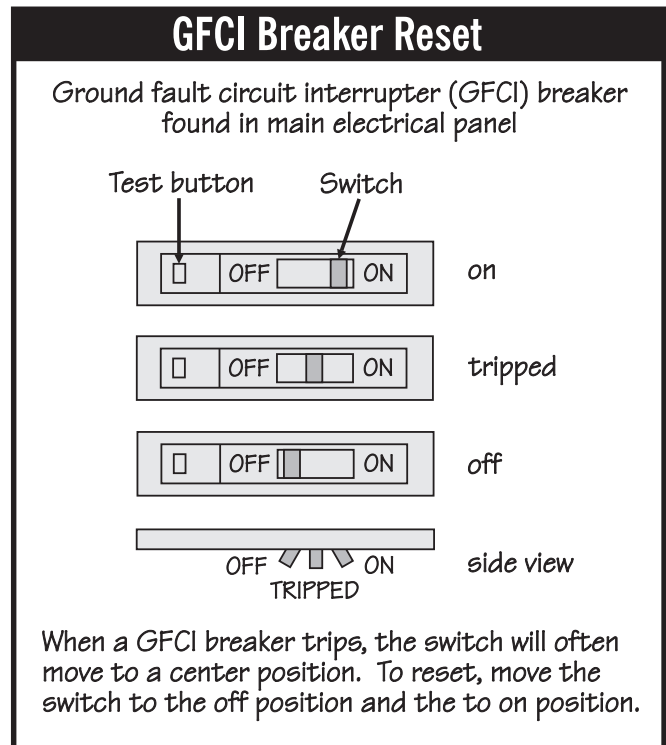

Figure 4-13.